



thermaltake

PC Power Fuction Test Report

Model:HP1-O21350GD-F14C 1350W

NO:RS202206090001

Version: **20220428 ATX Ver.3.0**

A. Introduction

B. Test Configuration

C. Conclusion

A.Introduction

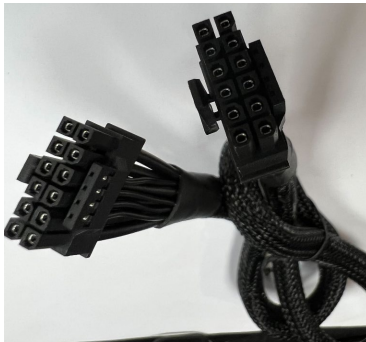

Product Source	Model Number	HP1-O21350GD-F14C 1350W																																								
Product Structure	Surface	Standard ATX Type																																								
	Output Connect	Normal																																								
	PFC Choke	Active Type																																								
Input Specification	Voltage	1.Input voltage range 90~264 Vac 2.Input normal voltage 100~240 Vac																																								
	Current	16.0A MAX																																								
	Frequency	47Hz~63Hz																																								
Output Specification	<table border="1"> <thead> <tr> <th>Output Voltage</th> <th>Load MIN</th> <th>Range MAX</th> <th>Load Regulation</th> <th>Total Regulation</th> <th>Ripple & Noise P-P Max.</th> </tr> </thead> <tbody> <tr> <td>+5V</td> <td>0.0A</td> <td>24A</td> <td>±2%</td> <td>±5%</td> <td>30mV</td> </tr> <tr> <td>+12V</td> <td>0.0A</td> <td>112.5A</td> <td>±2%</td> <td>+5% /-7%</td> <td>30mV</td> </tr> <tr> <td>-12V</td> <td>0.0A</td> <td>0.5A</td> <td>±5%</td> <td>±10%</td> <td>120mV</td> </tr> <tr> <td>+5Vs</td> <td>0.0A</td> <td>3.0A</td> <td>±5%</td> <td>±5%</td> <td>30mV</td> </tr> <tr> <td>+3.3V</td> <td>0.0A</td> <td>24A</td> <td>±3%</td> <td>±5%</td> <td>30mV</td> </tr> </tbody> </table>						Output Voltage	Load MIN	Range MAX	Load Regulation	Total Regulation	Ripple & Noise P-P Max.	+5V	0.0A	24A	±2%	±5%	30mV	+12V	0.0A	112.5A	±2%	+5% /-7%	30mV	-12V	0.0A	0.5A	±5%	±10%	120mV	+5Vs	0.0A	3.0A	±5%	±5%	30mV	+3.3V	0.0A	24A	±3%	±5%	30mV
	Output Voltage	Load MIN	Range MAX	Load Regulation	Total Regulation	Ripple & Noise P-P Max.																																				
	+5V	0.0A	24A	±2%	±5%	30mV																																				
	+12V	0.0A	112.5A	±2%	+5% /-7%	30mV																																				
	-12V	0.0A	0.5A	±5%	±10%	120mV																																				
	+5Vs	0.0A	3.0A	±5%	±5%	30mV																																				
	+3.3V	0.0A	24A	±3%	±5%	30mV																																				
<p>*⊙ The continuous total output power is 1350W max.</p> <ul style="list-style-type: none"> • The combined power of +5V and +3.3V is 120W max. <p>⊙ Add 0.1uF and 10uF capacitors across output terminal during ripple & noise test.</p>																																										

Test Objective :

This power supply product will be tested in accordance with the rules of **Intel ATX 3.0**.

To confirm all the functions and installed system can meet the requirements and also can operate smoothly.

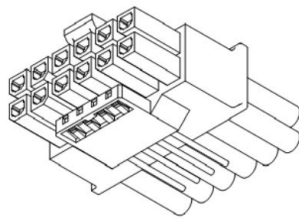

**ATX Version 3.0 Multi Rail
Desktop Platform Power Supply**

B. Test Configuration

1.Test Equipment

2.PC System Hardware List

3.ATX3.0 Power Function Test

4.The System Test

4.1.System Note Test

4.2.Burn-In Test

1. Test Equipment

Test Equipment

1	Chroma 6314 DC Electronic Load Main Frame
2	Chroma 6460 Programmable AC Source
3	Chroma 61604 Programmable AC Source
4	Tektronix TDS3014B Digital Phosphor Oscilloscope Test Fixture
5	BRYMEN Differential PROBE LDP-6110
6	YOKOGAWA Power Meter WT210
7	HIOKI Power Meter 3334
8	Fluke Multi Meter 111
9	TES Multi Meter 2360

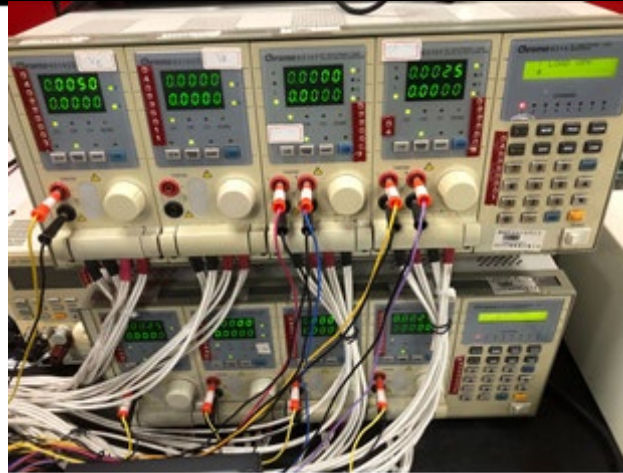

1. Chroma 6314 DC Electronic Load Main Frame



3. Chroma 61604 Programmable AC Source



2. Chroma 6460 Programmable AC Source

1.Test Equipment

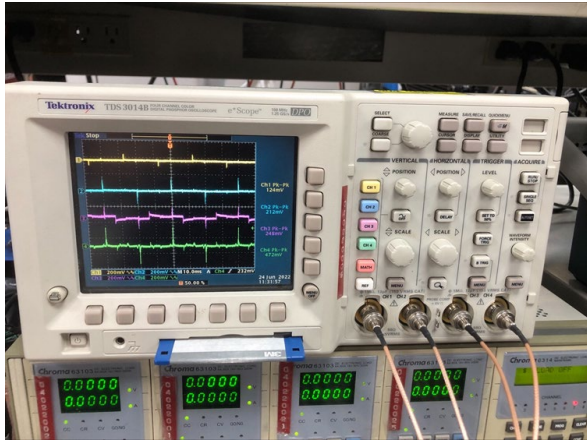

4. Tektronix TDS3014B Digital Phosphor Oscilloscope Test Fixture



5. BRYMEN Differential PROBE LDP-6110



6. YOKOGAWA Power Meter WT210

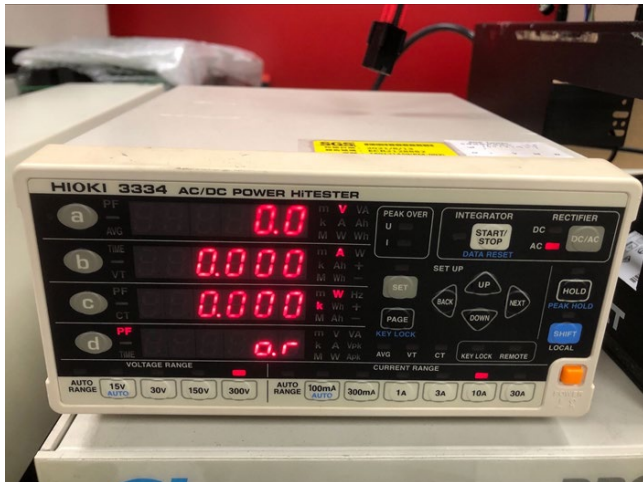

7. HIOKI Power Meter 3334

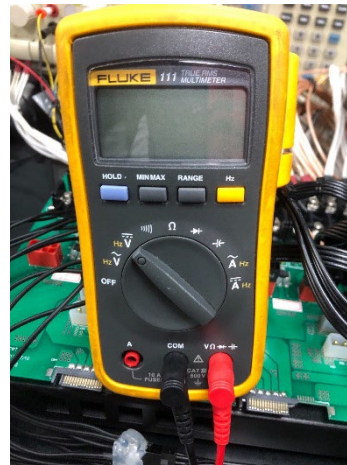

8. Fluke Multi Meter 111



9. TES Multi Meter 2360

Name	Quantity	Detail Spec
CPU	1	Intel Core i9 (10900K)
RAM	4	Tough RAM DDR4 4000HZ 8G
M.B.	1	ROG MAXIMUS XII HERO(WI-FI)
VGA Card	1	NVIDIA GTX3090TI
Hard Disk	1	PLEXTOR NVM Express SSD 500G
Monitor	1	LG UHD 4K 27UL850



PCI-E 5.0 12VHPWR

Power Function Test Item		
	Content Test Item	Test Result (Pass/Fail)
I. Input Test	1. Power Efficiency	Pass
	2. Power 2% or 10W Efficiency	Pass
	3. +5Vsb Power Efficiency	Pass
	4. ERP Lot6 Standard	Pass
II. Power Timing Test	1. Power on time	Pass
	2. Output Rise time	Pass
	3. Power Good Delay Time	Pass
	4. Power Good Signal Rise time	Pass
	5. Power Good Inactive to DC Loss Delay time	Pass
	6. AC Loss to Power Good hold up time	Pass
	7. AC Power on time	Pass
	8. 12VDC / 5VDC / 3.3VDC Power Sequencing	Pass
	9. Power on/off cycle mode	Pass
III. Output Test	1. Line Regulation	Pass
	2. Load Regulation	Pass
	3. Cross Load Regulation	Pass
	4. Transient Response	Pass
	5. Output Ripple & Noise	Pass
	6. Dynamic Load Test	Pass
	7. PCIe* AIC Peak Power Duty Cycle Test	NA/Pass
IV. Protection Function Test	1. Over Voltage Protection (O.V.P)	NA
	2. Over Power Protection (O.P.P)	Pass
	3. Short Circuit Protection (S.C.P)	Pass
	4. Over Current Protection (O.C.P)	NA



3.1.1 Power Efficiency

1.Test Condition:

Test the power supply with nominal line voltage and maximum load

2.Check:

Power Supply shall be a minimum percentage efficient under specified loading condition shown as below table

LOAD	5V	3.3V	+12V	-12V	+5VSB	SPEC
20%	2.59	2.62	20.37	0.09	0.54	87%
50%	6.55	6.55	50.93	0.23	1.36	90%
100%	13.09	13.09	101.86	0.45	2.72	87%

3.1. Input Test

High Power Gen5 1350W of efficiency test

Rating	1350W									Total Watt	Vac 115Vac/60HZ			
Combined	1350W				120W		6.00W	0.00W	15.00W	1491.00				
Output Voltage	12	12	12	12	3.3	5	-12	-5	5					
Loading	0.0A	0.0A	0.0A	112.5A	24.0A	24.0A	0.5A	0.0A	3.0A					
Watt	0W	0W	0W	1350W	79.2W	120W	6.0W	0.0W	15W					
Rate	+12V1	+12V2	+12V3	+12V4	+3.3V	+5V	-12V	-5V	+5VSB	Output power	Input power	Efficiency %	Input current	Power Factor
20%	0.00A	0.00A	0.00A	20.37A	2.62A	2.62A	0.09A	0.00A	0.54A	271.14	296.9	91.32%	2.6	0.99
				12.05V	3.31V	5.03V	-11.95V		5.03V					
50%	0.00A	0.00A	0.00A	50.93A	6.55A	6.55A	0.23A	0.00A	1.36A	678.31	739.4	91.74%	6.45	0.99
				12.06V	3.31V	5.03V	-11.96V		5.00V					
100%	0.00A	0.00A	0.00A	101.86A	13.09A	13.09A	0.45A	0.00A	2.72A	1356.21	1521.3	89.15%	13.25	0.99
				12.06V	3.30V	5.02V	-11.99V		4.94V					

PASS

Efficiency of the Power Supply

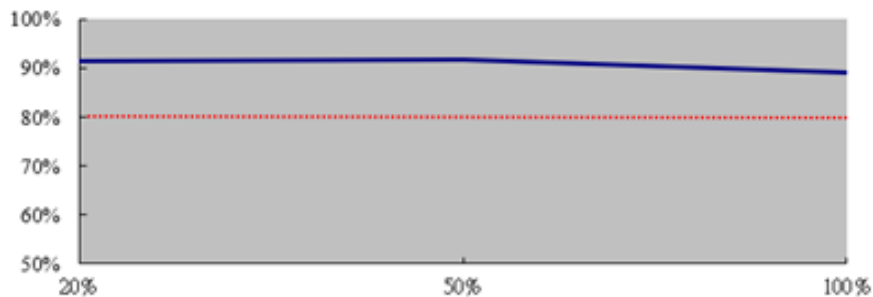

Input and Output Power

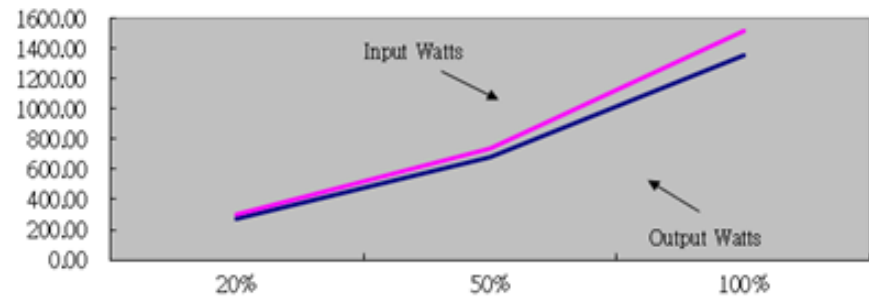

3.1. Input Test

High Power Gen5 1350W of efficiency test

Rating	1350W									Total Watt	Vac 230Vac/50HZ			
Combined	1350W				120W		6.00W	0.00W	15.00W	1491.00				
Output Voltage	12	12	12	12	3.3	5	-12	-5	5					
Loading	0.0A	0.0A	0.0A	112.5A	24.0A	24.0A	0.5A	0.0A	3.0A					
Watt	0W	0W	0W	1350W	79.2W	120W	6.0W	0.0W	15W					
Rate	+12V1	+12V2	+12V3	+12V4	+3.3V	+5V	-12V	-5V	+5VSB	Output power	Input power	Efficiency %	Input current	Power Factor
20%	0.00A	0.00A	0.00A	20.37A	2.62A	2.62A	0.09A	0.00A	0.54A	271.14	294.89	91.94%	1.34	0.96
				12.05V	3.31V	5.03V	-11.95V		5.03V					
50%	0.00A	0.00A	0.00A	50.93A	6.55A	6.55A	0.23A	0.00A	1.36A	678.31	726.1	93.42%	3.19	0.99
				12.06V	3.31V	5.03V	-11.97V		5.00V					
100%	0.00A	0.00A	0.00A	101.86A	13.09A	13.09A	0.45A	0.00A	2.72A	1356.21	1476.6	91.85%	6.43	0.99
				12.06V	3.30V	5.02V	-11.99V		4.94V					

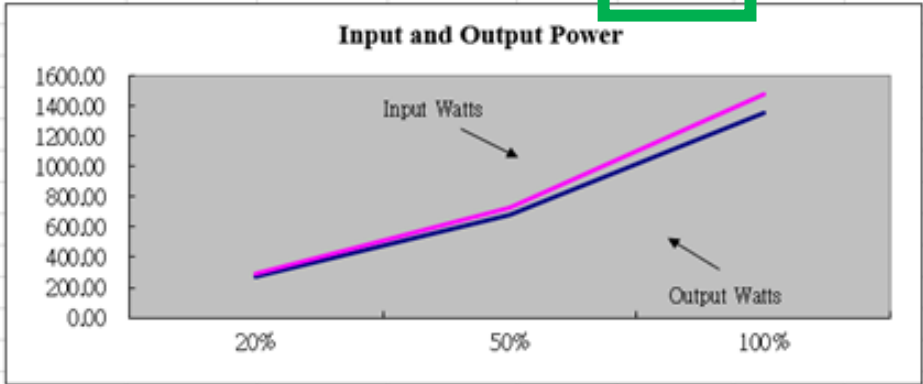
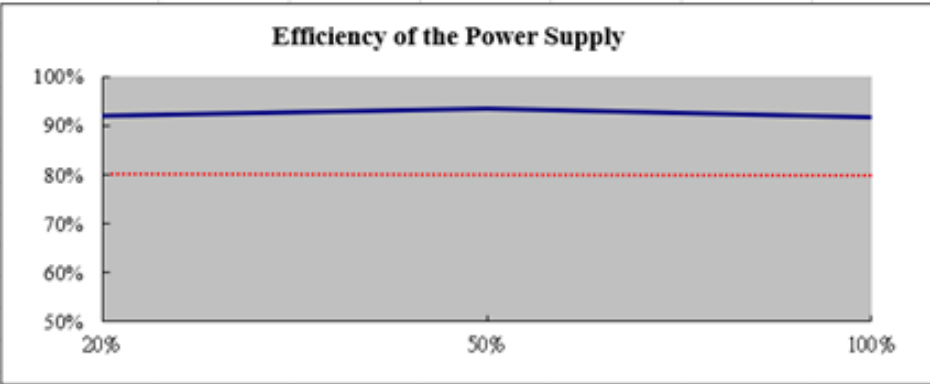
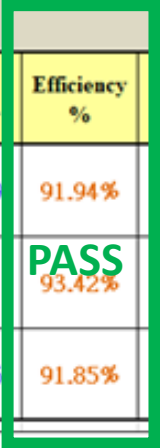

3.1.2 Power 2% or 10W Efficiency

1.Test Condition:

Test the power supply with Low load efficiency

2.Check:

Power Supply rating above 500W shall be test 2 percentage efficient

Power Supply rating under 500W shall be test 10W efficient

specified loading condition shown as below table

LOAD	5V	3.3V	+12V	-12V	+5VSB	SPEC
2%	0.26	0.26	2.04	0.01	0.05	70%
10W	0.10	0.10	0.75	0.00	0.02	70%

3.1. Input Test

High Power Gen5 1350W of 2% or 10W efficiency test

Rating	1350W									Total Watt	Vac 115Vac/60HZ			
Combined	1350W				120W		6.00W	0.00W	15.00W	1491.00	&			
Output Voltage	12	12	12	12	3.3	5	-12	-5	5		Vac 230Vac/50Hz			
Loading	0.0A	0.0A	0.0A	112.5A	24.0A	24.0A	0.5A	0.0A	3.0A					
Watt	0W	0W	0W	1350W	79.2W	120W	6.0W	0.0W	15W					
115Vac														
Rate	+12V1	+12V2	+12V3	+12V4	+3.3V	+5V	-12V	-5V	+5VSB	Output power	Input power	Efficiency %	Input current	Power Factor
2%	0.00A	0.00A	0.00A	2.04A	0.26A	0.26A	0.01A	0.00A	0.05A	26.94	36.25	74.32%	0.37	0.86
				11.96V	3.35V	5.04V	-11.89V		5.03V					
230Vac														
Rate	+12V1	+12V2	+12V3	+12V4	+3.3V	+5V	-12V	-5V	+5VSB	Output power	Input power	Efficiency %	Input current	Power Factor
2%	0.00A	0.00A	0.00A	2.04A	0.26A	0.26A	0.01A	0.00A	0.05A	26.96	35.73	75.45%	0.32	0.48
				11.96V	3.41V	5.04V	-11.89V		5.03V					

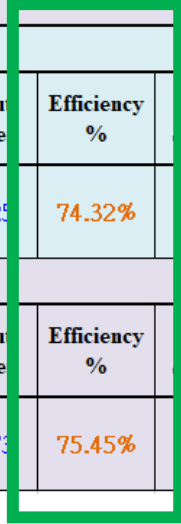

PASS

3.1.3 +5Vsb POWER EFFICIENCY

1. Test Condition:

Test the power supply with AC115 and AC 230V voltage and +5Vsb loading

2.Check:

Power Supply shall be a minimum percentage efficient under specified loading condition shown as below table

SPEC

5VSB Load Target	5VSB Actual Load	Efficiency Target (both 115V and 230V Input)	Remark
Max / Label	3.0A / Label	75%	Recommend
1.5 A		75%	REQUIRED ALPM and ErP Lot 3 2014
1.00 A		75%	Recommend
0.55 A		75%	REQUIRED ALPM and ErP* Lot 3 2014
90 mA		55%	Recommend
45 mA		45%	REQUIRED ErP* Lot 6 2013

+5Vsb Load condition
0A
0.045A
0.09A
0.10A
0.25A
0.55A
1.0A
1.5A
2.0A
2.5A
3.0A

3.1. Input Test

AC Input Voltage	+5Vsb Loading	Measured Voltage	Measured min / mWh	Input Power	Output Power	Efficiency data(%)	2013 Efficiency standard
115V /60Hz	0.045A	5.046V	5 min	0.290796	0.22707	78.09%	> 45%
			0.024233				
	0.090A	5.045V	5 min	0.65478	0.45405	69.34%	> 45%
			0.054565				
	0.10A	5.045V	5 min	0.714288	0.5045	70.63%	> 55%
			0.059524				
	0.25A	5.042V	5 min	1.65336	1.2605	76.24%	> 65%
			0.137780				
	0.55A	5.036V	5 min	3.5268	2.7698	PASS 78.54%	> 75%
			0.293900				
1.0A	5.027V	5 min	6.3516	5.027	79.15%	> 75%	
		0.529300					
1.5A	5.017V	5 min	9.45432	7.5255	79.60%	> 75%	
		0.787860					
2.0A	5.009V	5 min	12.6204	10.018	79.38%	> 75%	
		1.051700					
2.5A	4.999V	5 min	15.7404	12.4975	79.40%	> 75%	
		1.311700					
3.0A	4.99V	5 min	18.9012	14.97	79.20%	> 75%	
		1.575100					

3.1. Input Test

AC Input Voltage	+5Vsb Loading	Measured Voltage	Measured min / mWh	Input Power	Output Power	Efficiency data(%)	2013 Efficiency standard
230V /50Hz	0.045A	5.046V	5 min	0.425376	0.22707	53.38%	> 45%
			0.035448				
	0.090A	5.045V	5 min	0.698508	0.45405	65.00%	> 45%
			0.058209				
	0.10A	5.044V	5 min	0.756144	0.5044	66.71%	> 55%
			0.063012				
	0.25A	5.042V	5 min	1.71036	1.2605	73.70%	> 65%
			0.142530				
	0.55A	5.036V	5 min	3.59292	2.7698	77.09%	> 75%
			0.299410				
1.0A	5.027V	5 min	6.40512	5.027	78.48%	> 75%	
		0.533760					
1.5A	5.018V	5 min	9.51528	7.527	79.10%	> 75%	
		0.792940					
2.0A	5.008V	5 min	12.5652	10.016	79.71%	> 75%	
		1.047100					
2.5A	4.999V	5 min	15.5856	12.4975	80.19%	> 75%	
		1.298800					
3.0A	4.989V	5 min	18.6276	14.967	80.35%	> 75%	
		1.552300					

3.1.4 ERP Lot6 Standard

1. Test condition & Test result

PASS

AC Input Voltage	+5Vsb Loading	Input power consumption	2013 ErP Lot6 Standard
115V/60Hz	0A	0.02W	<0.5W
230V/50Hz	0A	0.216W	<0.5W

3.2 Power Efficiency

1. Test Condition:

- (1.) Test the power supply Input condition at low line and high line
- (2.) The test load condition with spec each output rail maximum load

2. Check:

Check T1~T6 under the various test conditions

Parameter	Description	Value		
		Legacy Timings ¹	Required	Recommended for ALPM
T0	AC power on time	-	<2s	-
T1	Power-on time	< 500 ms	< 200 ms	<150 ms
T2	Rise time	-	0.2 – 20 ms	-
T3	PWR_OK delay	100 ms ² – 500 ms	100 ms ² – 250 ms	100 ms ² – 150 ms
T4	PWR_OK rise time	-	< 10 ms	-
T5	AC loss to PWR_OK hold-up time ³	-	> 16 ms	-
T6	PWR_OK inactive to DC loss delay	-	> 1 ms	-

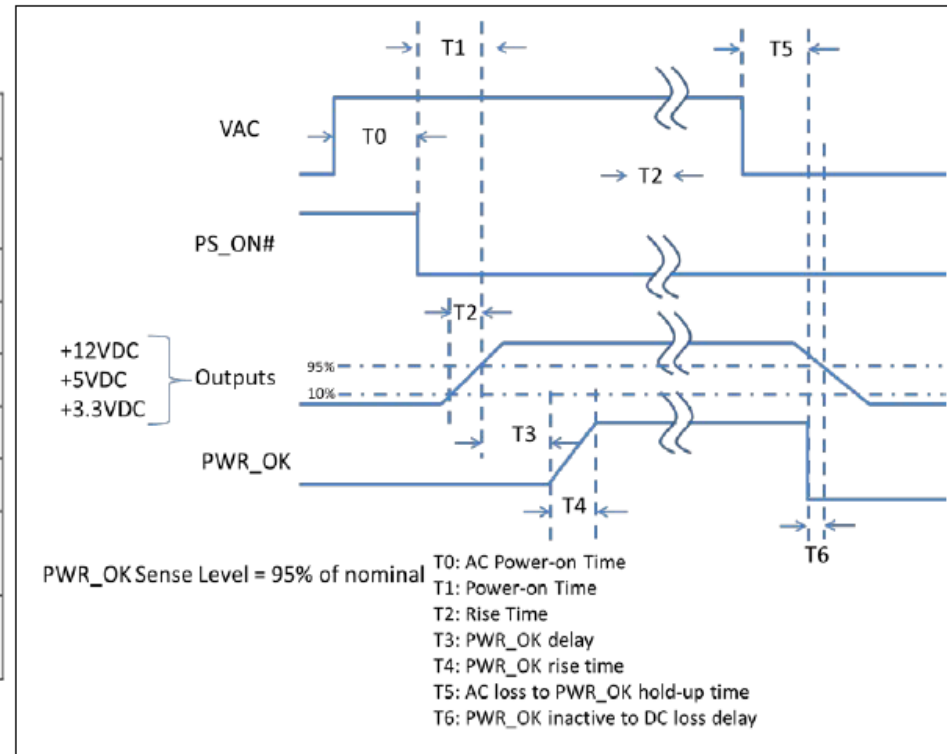

3.2.1 Power on time

1. Test Result

T1 Condition test									
Power on Time									
Output Load Condition	Input Voltage (Vac)	Output	Output Load Condition (A)					PASS Data (msec)	Spec (msec)
			+5V	+3.3V	+12V	-12V	5Vsb		
Full Load	100Vac (60HZ)	+5V	24.00	0.00	100.75	0.50	3.00	156	< 200 (ATX ver3.0)
		+3.3V	8.16	24.00	100.75	0.50	3.00	160	
		+12V	0.00	0.00	111.58	0.50	1.00	158	
	240Vac (50HZ)	+5V	24.00	0.00	100.75	0.50	3.00	95.2	
		+3.3V	8.16	24.00	100.75	0.50	3.00	95.6	
		+12V	0.00	0.00	111.58	0.50	1.00	89.6	

3.2.2 Output Rise time

1.Test Result

T2 Condition test									
Output Rise Time									
Output Load Condition	Input Voltage (Vac)	Output	Output Load Condition (A)					PASS Data (msec)	Intel spec (msec)
			+5V	+3.3V	+12V	-12V	5Vsb		
Full Load	100Vac (60HZ)	+5V	24.00	0.00	100.75	0.50	3.00	2.327	0.2~20
		+3.3V	8.16	24.00	100.75	0.50	3.00	2.221	
		+12V	0.00	0.00	111.58	0.50	1.00	6.295	
	240Vac (50HZ)	+5V	24.00	0.00	100.75	0.50	3.00	2.3	
		+3.3V	8.16	24.00	100.75	0.50	3.00	2.226	
		+12V	0.00	0.00	111.58	0.50	1.00	6.307	

3.2.3 Power Good Delay Time

1. Test Result

T3 Condition test									
Power Good Delay Time									
Output Load Condition	Input Voltage (Vac)	Output	Output Load Condition (A)					PASS Data (msec)	Spec (msec)
			+5V	+3.3V	+12V	-12V	5Vsb		
Full Load	100Vac (60HZ)	+5V	24.00	0.00	100.75	0.50	3.00	123	100~250 (ATX ver3.0)
		+3.3V	8.16	24.00	100.75	0.50	3.00	125	
		+12V	0.00	0.00	111.58	0.50	1.00	131	
	240Vac (50HZ)	+5V	24.00	0.00	100.75	0.50	3.00	124	
		+3.3V	8.16	24.00	100.75	0.50	3.00	126	
		+12V	0.00	0.00	111.58	0.50	1.00	128	

3.2.4 Power Good Signal Rise time

1. Test Result

*1msec = 10⁶ nsec

T4 Condition test									
Power Good Rise Time									
Output Load Condition	Input Voltage (Vac)	Output	Output Load Condition (A)					PASS Data (nsec)	Spec (msec)
			+5V	+3.3V	+12V	-12V	5Vsb		
Full Load	100Vac (60HZ)	+5V	24.00	0.00	100.75	0.50	3.00	833.7	<10
		+3.3V	8.16	24.00	100.75	0.50	3.00	833.4	
		+12V	0.00	0.00	111.58	0.50	1.00	844.3	
	240Vac (50HZ)	+5V	24.00	0.00	100.75	0.50	3.00	821.5	
		+3.3V	8.16	24.00	100.75	0.50	3.00	816.7	
		+12V	0.00	0.00	111.58	0.50	1.00	838.2	

3.2.5 Power Good Inactive to DC Loss Delay time

1. Test Result

T6 Condition test									
Power Good Inactive to DC Loss Delay time									
Output Load Condition	Input Voltage (Vac)	Output	Output Load Condition (A)					Data (msec)	Spec (msec)
			+5V	+3.3V	+12V	-12V	5Vsb		
Full Load	100Vac (60HZ)	+5V	24.00	0.00	100.75	0.50	3.00	33.3	> 1
		+3.3V	8.16	24.00	100.75	0.50	3.00	33.1	
		+12V	0.00	0.00	111.58	0.50	1.00	7.84	
	240Vac (50HZ)	+5V	24.00	0.00	100.75	0.50	3.00	33.2	
		+3.3V	8.16	24.00	100.75	0.50	3.00	33.2	
		+12V	0.00	0.00	111.58	0.50	1.00	7.92	

PASS

3.2.6 Hold Up time (AC Loss to DC Loss Delay time)

1. Test Result

T5 + T6 Condition test									
Hold Up time									
Output Load Condition	Input Voltage (Vac)	Output	Output Load Condition (A)					Data (msec)	Spec (msec)
			+5V	+3.3V	+12V	-12V	5Vsb		
Full Load	100Vac (60HZ)	+5V	24.00	0.00	100.75	0.50	3.00	49.6	>16
		+3.3V	8.16	24.00	100.75	0.50	3.00	49.8	
		+12V	0.00	0.00	111.58	0.50	1.00	25.2	
	240Vac (50HZ)	+5V	24.00	0.00	100.75	0.50	3.00	49.0	
		+3.3V	8.16	24.00	100.75	0.50	3.00	49.4	
		+12V	0.00	0.00	111.58	0.50	1.00	25.0	

PASS

3.2.7 AC Power on Time

1. Test Condition:

(1.) Test the power supply Input condition at low line and high line

(2.) The test load condition with spec each output rail maximum load

Check:

With new modes of operation for computers like Alternative Low Power Modes (ALPM) the continuous current rating of the 5VSB rail is recommended to be at least 3A. Some scenarios like USB Power Charging in ALPM could require more current on the 5VSB rail.

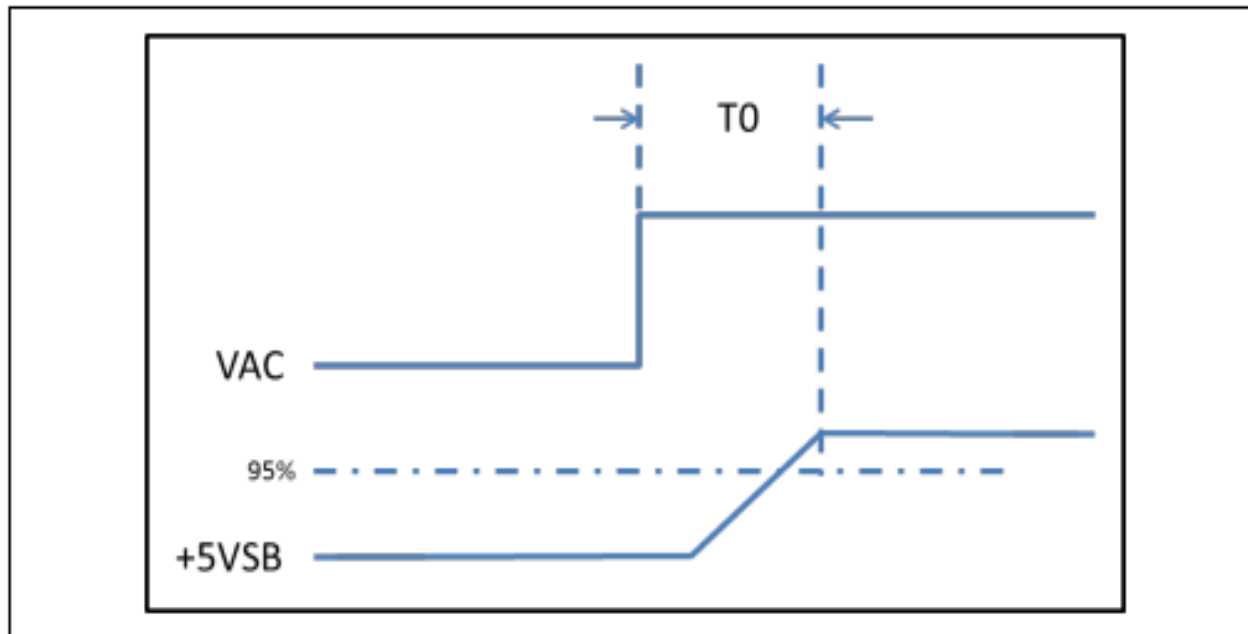

1. Test Result

*1sec = 10³ msec

T0 Condition test					
AC Power on Time					
Output Load Condition	Input Voltage (Vac)	Output	Output Load Condition (A)	PASS Data (msec)	Spec (sec)
Full Load	100Vac (60HZ)	+5Vsb	3	498	< 2s
	240Vac (50HZ)			149	

3.2.8 12V DC / 5V DC / 3.3V DC Power Sequencing

1. Test Condition:

- (1.) Test the power supply Input condition at low line and high line
- (2.) The test load condition with spec each output rail maximum load

2. Check:

The +12V1 DC / +12V2 DC and +5VDC output levels must be equal to or greater than the +3.3 VDC output of +12V1 DC / +12V2 DC and +5VDC reaching its minimum in-regulation level and +3.3VDC reaching its minimum in-regulation level must be ≤ 20 ms as shown in below figure.

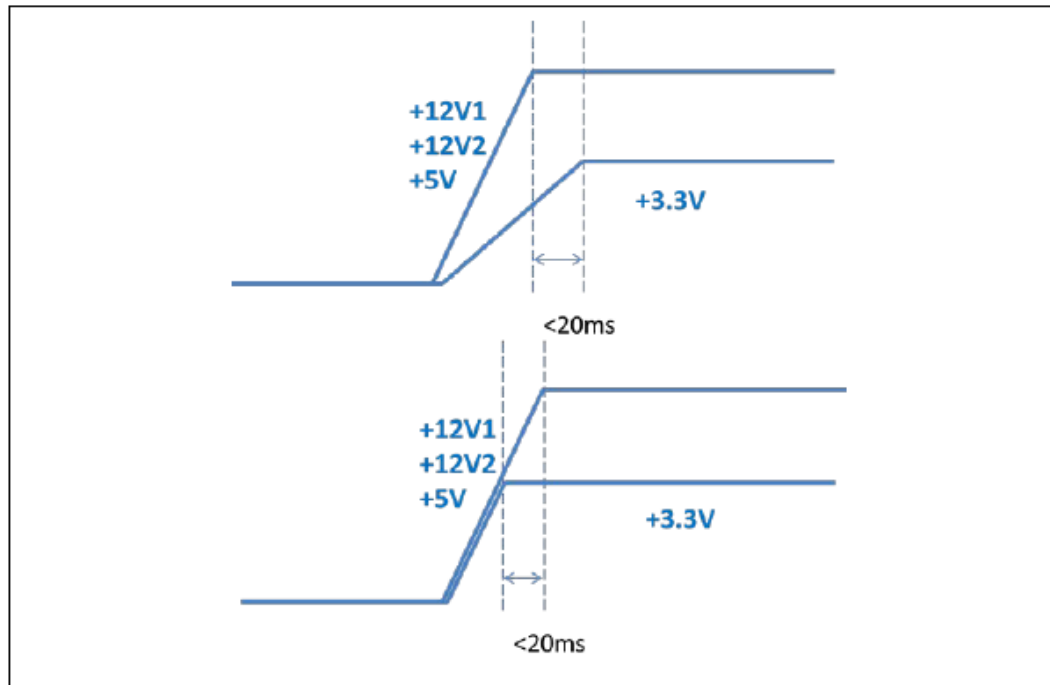

1. Test Result

12V DC / 5V DC / 3.3V DC Power Sequencing Condition test									
12V DC / 5V DC / 3.3V DC Power Sequencing									
Output Load Condition	Input Voltage (Vac)	Output	Output Load Condition (A)					Data (msec)	Spec (msec)
			+5V	+3.3V	+12V	-12V	5Vsb		
Full Load	100Vac (60HZ)	+5V	24.00	0.00	100.75	0.50	3.00	1.76	≤ 20
		+3.3V	8.16	24.00	100.75	0.50	3.00	1.52	
		+12V	0.00	0.00	111.58	0.50	1.00	1.44	
	240Vac (50HZ)	+5V	24.00	0.00	100.75	0.50	3.00	1.68	
		+3.3V	8.16	24.00	100.75	0.50	3.00	1.6	
		+12V	0.00	0.00	111.58	0.50	1.00	1.76	

3.2.9 Power On/Off Cycle Mode

1. Test Condition:

Use Scope to measure PG signal in 24Pin main connector at no load condition.

2. Check

The PG signal always rises to “Hi” when the PS_ON is start.

3. Test Result: PASS

3.3.1. LINE REGULATION

1.1 Test Condition & Check

Purpose: Measure the stability of the output voltage when the input voltage is variable

Environmental Condition: Temperature 25C relative Humidity 65%

Test Condition:

- 1.The input voltage frequency must be under any condition in the range of the product specification
- 2.The output load is full load on all outputs at under the product specification
- 3.Test can be performed only after the SPS is on for about 10 minutes

Result Limit: The output voltage can't exceed the allowed difference

Output Load	Output Load Condition (A)				
	+5V	+3.3V	+12V	-12V	+5Vsb
Full Load	13.09	13.09	101.86	0.45	2.72

1.2 Test Result

Vin \ Vout	+5V (V)	+3.3V (V)	+12V (V)	-12V (V)	+5Vsb (V)
100V/60HZ	5.02	3.30	12.00	-12.00	4.94
115V/60HZ	5.02	3.30	12.00	-12.00	4.94
132V/60HZ	5.02	3.30	12.00	-12.00	4.94
180V/50HZ	5.02	3.30	12.00	-11.99	4.94
230V/50HZ	5.02	3.30	12.00	-11.99	4.94
240V/50HZ	5.02	3.30	12.00	-11.99	4.94
Spec	±2%	±3%	±2%	±5%	±5%

PASS

3.3.2. LOAD REGULATION

2.1 Test Condition & Check

Purpose: Measure the stability of the output voltage when the load is variable

Environmental Condition: Temperature 25C relative Humidity 65%

Test Condition:

1.The input voltage frequency must be under any condition in the range of the product specification

2.Output Load Maximum , Middle , Minimum load by the product specification

Result Limit: The output voltage do not exceed the allowed difference

Output Load	Output Load Condition (A)				
	+5V	+3.3V	+12V	-12V	+5Vsb
Min Load	0.0	0.0	0.0	0.0	0.0
Half Load	6.55	6.55	50.93	0.23	1.36
Full Load	13.09	13.09	101.86	0.45	2.72

2.2 Test Result

Vin	Load	Vout	+5V (V)	+3.3V (V)	+12V (V)	-12V (V)	+5Vsb (V)
100V/60HZ	Min Load		5.04	3.32	12.01	-11.94	5.05
	Half Load		5.03	3.31	12.03	-11.97	4.99
	Full Load		5.02	3.30	12.00	-12.00	4.94
115V/60HZ	Min Load		5.04	3.32	12.01	-11.94	5.05
	Half Load		5.03	3.31	12.03	-11.97	4.99
	Full Load		5.02	3.30	12.00	-12.00	4.94
132V/63HZ	Min Load		5.04	3.32	12.01	-11.94	5.05
	Half Load		5.03	3.31	12.03	-11.97	4.99
	Full Load		5.02	3.30	12.00	-12.00	4.94
180V/47HZ	Min Load		5.04	3.32	12.00	-11.94	5.05
	Half Load		5.03	3.31	12.03	-11.97	5.00
	Full Load		5.02	3.30	12.00	-11.99	4.94
230V/50HZ	Min Load		5.04	3.32	12.00	-11.94	5.05
	Half Load		5.03	3.31	12.03	-11.97	5.00
	Full Load		5.02	3.30	12.00	-11.99	4.94
240V/50HZ	Min Load		5.04	3.32	12.00	-11.94	5.05
	Half Load		5.03	3.31	12.03	-11.97	5.00
	Full Load		5.02	3.30	12.00	-11.99	4.94
	Spec		±2%	±3%	±2%	±5%	±5%

PASS

3.3.3.CROSS LOAD REGULATION

3.1 Test Condition & Check

1.Test Condition:

Test the power supply one the Auto tester at low line to high line and under all possible

Combinations of output loads except specified.

	+5V	+3.3V	+12V	-12V	+5Vsb
LOAD1	24.00	0.00	100.75	0.50	3.00
LOAD2	8.16	24.00	100.75	0.50	3.00
LOAD3	0.00	0.00	111.58	0.50	1.00
LOAD4	0	0	0	0	0
LOAD5	2.62	2.62	20.37	0.09	0.54
LOAD6	6.55	6.55	50.93	0.23	1.36
LOAD7	13.09	13.09	101.86	0.45	2.72

2.Check:

The DC Output voltage shall remain follow with in the regulation ranges specified in the standard

Specification when measured at the load end of the output connectors.

3.3.Output Test

3.2 Test Result

Output Voltage	+5V(V)	+3.3V(V)	+12V(V)	-12V(V)	+5Vsb(V)
AC Input Condition	AC Input 100Vac 60HZ				
Load 1	5.03	3.30	12.00	-11.98	4.94
Load 2	5.02	3.30	12.00	-11.99	4.93
Load 3	5.03	3.31	12.01	-11.96	4.99
Load 4	5.04	3.32	12.01	-11.94	5.05
Load 5	5.04	3.31	12.04	-11.96	5.03
Load 6	5.03	3.31	12.03	-11.97	4.99
Load 7	5.02	3.30	12.00	-12.00	4.94
Spec	±2%	±3%	±2%	±5%	±5%

PASS

Output Voltage	+5V(V)	+3.3V(V)	+12V(V)	-12V(V)	+5Vsb(V)
AC Input Condition	AC Input 240Vac 50HZ				
Load 1	5.03	3.30	12.00	-11.98	4.94
Load 2	5.02	3.30	12.00	-11.99	4.93
Load 3	5.03	3.31	12.02	-11.96	4.99
Load 4	5.04	3.32	12.00	-11.94	5.05
Load 5	5.04	3.31	12.04	-11.96	5.03
Load 6	5.03	3.31	12.03	-11.97	5.00
Load 7	5.02	3.30	12.00	-11.99	4.94
Spec	±2%	±3%	±2%	±5%	±5%

PASS

3.3.4. Transient Response

4.1 Test Condition & Check

1.Test Condition:

Follow as below condition table.

2.Test Purpose

Simulate PSU at transient response 20% to 50% load situation with below table different changing repetition rate conditions

Output voltage	+5V	+3.3V	+12V	-12V	+5Vsb
Load slew rate	1A/us	1A/us	1A/us	200mA/us	200mA/us
Load changing repetition rate	20msec	20msec	20msec	20msec	20msec
	1msec	1msec	1msec	1msec	1msec

3.Check:

Compare with transient response load and before changing condition, and the voltage regulation should be follow the spec see below table

4.2 Test Result

Input Voltage (100Vac)	Load change repetition	Output Load Condition 20% - 50%			
		Before	After	Change Rate	Spec
+5V	20ms	5.038	5.031	0.14%	±5%
	1ms		5.030	0.16%	
+3.3V	20ms	3.316	3.310	0.18%	±5%
	1ms		3.310	0.18%	
+12V	20ms	12.000	12.030	-0.25%	±5%
	1ms		12.040	-0.33%	
-12V	20ms	-11.920	-11.960	-0.34%	±5%
	1ms		-11.960	-0.34%	
+5Vsb	20ms	5.048	5.011	0.73%	±5%
	1ms		5.011	0.73%	

PASS

Input Voltage (240Vac)	Load change repetition	Output Load Condition 20% - 50%			
		Before	After	Change Rate	Spec
+5V	20ms	5.038	5.031	0.14%	±5%
	1ms		5.031	0.14%	
+3.3V	20ms	3.316	3.310	0.18%	±5%
	1ms		3.310	0.18%	
+12V	20ms	12.000	12.040	-0.33%	±5%
	1ms		12.040	-0.33%	
-12V	20ms	-11.920	-11.960	-0.34%	±5%
	1ms		-11.960	-0.34%	
+5Vsb	20ms	5.048	5.011	0.73%	±5%
	1ms		5.011	0.73%	

PASS

3.3.5. OUTPUT RIPPLE & NOISE

5.1 Test Condition & Check

1.Test Condition:

Power on the UUT at AC input low range and AC input high range, than measured the UUT under load condition shown on as the below table (Noise bandwidth is from 20MHZ. Add 0.1uf ceramic capacitor in parallel with a 10uf tantalum capacitor at output connector terminals for ripple & noise measurements.)

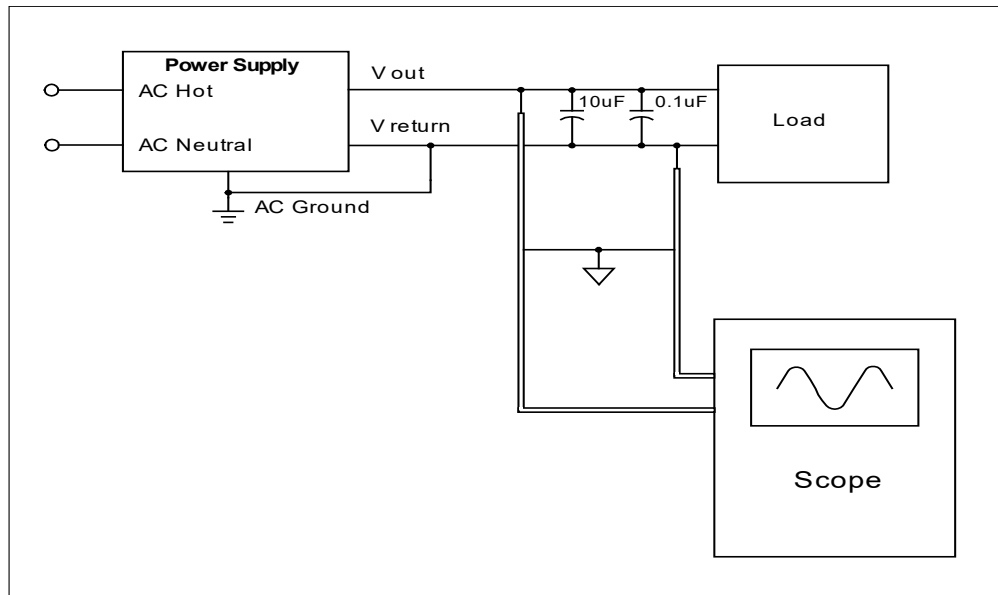

2.Check:

Measure the output ripple and peak to peak voltage ,
The ripple of power supply should be follow with in the specification
(Shown on the worst case of the each output and attached the waveform . As follows)

5.2 Load Condition

	+5V	+3.3V	+12V	-12V	+5Vsb
LOAD1	24.00	0.00	100.75	0.50	3.00
LOAD2	8.16	24.00	100.75	0.50	3.00
LOAD3	0.00	0.00	111.58	0.50	1.00
LOAD4	0	0	0	0	0
LOAD5	2.62	2.62	20.37	0.09	0.54
LOAD6	6.55	6.55	50.93	0.23	1.36
LOAD7	13.09	13.09	101.86	0.45	2.72

5.3 Test Result

PASS

PASS

Output Voltage	Measured value (mv)				
	+5V	+3.3V	+12V	-12V	+5Vsb
AC Input Condition	AC Input 100Vac 60Hz				
Load 1	10.2	5.8	25.2	24.0	8.6
Load 2	11.6	7.6	25.2	24.8	9.4
Load 3	7.0	5.4	24.2	22.2	9.0
Load 4	3.2	2.0	10.0	10.0	11.0
Load 5	4.6	3.4	13.8	16.0	4.6
Load 6	7.0	5.4	17.2	21.2	7.4
Load 7	11.8	7.2	25.2	23.6	8.8
Max value	11.8	7.6	25.2	24.8	11.0
Spec	30mV	30mV	30mV	120mV	30mV

Output Voltage	Measured value (mv)				
	+5V	+3.3V	+12V	-12V	+5Vsb
AC Input Condition	AC Input 240Vac 50Hz				
Load 1	9.6	6.0	24.8	27.6	9.0
Load 2	11.0	7.8	25.4	25.0	8.8
Load 3	6.6	4.6	25.4	22.4	8.6
Load 4	3.2	2.4	9.4	10.0	12.0
Load 5	4.8	4.0	12.8	16.0	5.0
Load 6	6.6	4.6	15.2	20.8	7.4
Load 7	11.2	7.2	25.2	24.0	9.0
Max value	11.2	7.8	25.4	27.6	12.0
Spec	30mV	30mV	30mV	120mV	30mV

3.3.6. DYNAMIC LOAD

6.1 Test Condition & Check

1.Test Condition:

Follow as below condition table.

2.Test Purpose

PSU of load simulate computer of load condition

Output voltage	+5V	+3.3V	+12V	-12V	+5Vsb
Load slew rate	1A/us	1A/us	1A/us	0.2A/us	0.2A/us
Load changing repetition rate	10msec	10msec	10msec	10msec	10msec

3.Check:

PSU no any shut down state and no any fault condition during the test

6.2 Test Result

Input Voltage (Vac)	Output Load Condition (A)					Test time	Test result (Pass/Fail)
	+5V	+3.3V	+12V	-12V	5Vsb		
100Vac/60HZ	6.00~12.00	9.09~18.18	50.38~100.75	0.25~0.50	1.50~3.00	1h	Pass
240Vac/50HZ	6.00~12.00	9.09~18.18	50.38~100.75	0.25~0.50	1.50~3.00	1h	Pass

3.3.7.PCIe* AIC Peak Power Duty Cycle test

7.1 Test Condition & Check

1.Test Condition:

Follow as below condition table.

Table 3-3: PCIe* AIC and PSU Power Budget used for Peak Power Excursion

Power Excursion % of PSU Rated Size PSU ≤ 450 Watts & PSUs without 12VHPWR Connector	Power Excursion % of PSU Rated Size PSU > 450 Watts & 12VHPWR Connector present	Time for Power Excursion (TE)	Testing Duty Cycle
100%	100%	Infinite	--
110%	120%	100 ms	50%
135%	160%	10 ms	25%
145%	180%	1 ms	20%
150%	200%	100 μs	10%

Figure 3-2: Duty Cycle Definition

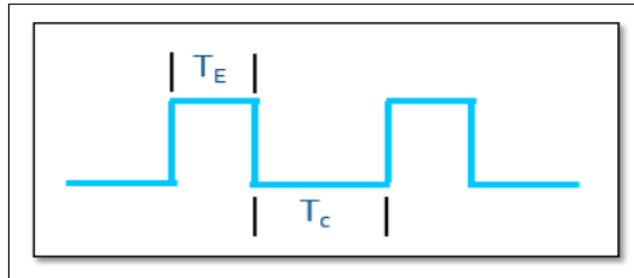

2.Test Purpose

Simulate PSU at above table duty cycle 10%, 20%, 25%, 50% load situation.

Test input voltage at low line and high line, 10min test time for each Duty Cycle part.

3.Check:

PSU no any shut down state and no any fault condition during the test



7.2 Test Result

Input Voltage (Vac)	Testing Duty Cycle	Output Load Condition (A)		Test time	Test result (Pass/Fail)
		12V			
		TE	TC		
100Vac/60HZ	10%	225.00	91.86	10m	NA
	20%	202.50	74.63	10m	Pass
	25%	180.00	77.95	10m	Pass
	50%	135.00	84.19	10m	Pass
240Vac/50HZ	10%	225.00	91.86	10m	NA
	20%	202.50	74.63	10m	Pass
	25%	180.00	77.95	10m	Pass
	50%	135.00	84.19	10m	Pass

3.4.1. OVER VOLTAGE PROTECTION (O.V.P)

3.1 Test Condition & Check

3.4.2. OVER POWER PROTECTION (O.P.P)

2.1 Test Condition & Check

1.Test Condition:

Test input voltage at low line and high line, when over power for output load the PSU must be self protection.

2.Check:

- (1.) Check PSU reach over power protection point is latched in spec range.
- (2.) The PSU can be restart and normal working when over load condition was removed.

2.2 Test Result

Input	Over power Condition (W)			
	Rating Power (W)	Over Power Spec	Test Over Power Point (W)	Over Power (%)
100Vac 60Hz	1350W	130%~170%	NA (Over equipment limit)	NA (Over equipment limit)
240Vac 50Hz	1350W	130%~170%	NA (Over equipment limit)	NA (Over equipment limit)

PASS

3.4.3. SHORT CIRCUIT PROTECTION (S.C.P)

3.1 Test Condition & Check

1. Test Condition:

Input Power On the power supply at nominal line and the UUT is min load condition.

And max load condition

Output Load	Output Load Condition (A)				
	+5V	+3.3V	+12V	-12V	+5Vsb
Min Load	0.0	0.0	0.0	0.0	0.0

2. Check:

(1.) Check the power supply is latched when any output is short circuit. The power supply can be turned on normal by AC line or remote on if the short circuit fault is removed.

(2.) Short circuit the +5Vsb should cause all of the outputs remain low until the short circuit is removed.

3.2 Test Result

Input Voltage	+5V	+3.3V	+12V	-12V	5VSB
100Vac/60HZ	Latch	Latch	Latch	Latch	Auto Recovery
240Vac/50HZ	Latch	Latch	Latch	Latch	Auto Recovery

PASS

3.4.4. SHORT CIRCUIT PROTECTION (S.C.P)

3.1 Test Condition & Check

3.4.1. The System Note Test

3.4.1.Test Condition:

A.The system devices

Name	Quantity	Detail Spec
CPU	1	Intel Core i9 (10900K)
RAM	4	Tough RAM DDR4 4000HZ 8G
M.B.	1	ROG MAXIMUS XII HERO(WI-FI)
VGA Card	1	NVIDIA GTX3090TI, GTX3090, GTX3080
Hard Disk	1	PLEXTOR NVM Express SSD 500G
Monitor	1	LG UHD 4K 27UL850

B. Test Software:

1. 3Dmark
2. Game benchmark

2.Check:

- (1.) The tester will not hear electronic noise form PSU within the 30cm.
- (2.) The case must be close side panel.
- (3.) Test Time: **1 hour**

3.Test Result: Pass

PASS

3.4.2.Burn-In Test

1.Test Condition:

- a. Follow up system devices
- b. Test Software: O.C.C.T

2.Check:

- (1.) All tests does not occur shutdown, reboot or any defective status.
- (2.) Test time: **1 hour**

3.Test Result: Pass

PASS

C. Conclusion

This product has been tested and passed the regulation of **Intel ATX 3.0** for the power supply product. Under the latest Video card 3090 TI , it can also operate smoothly and stably, ensuring the highest performance.

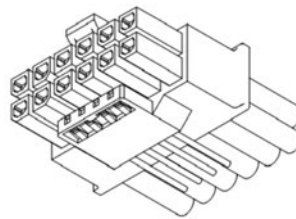

**ATX Version 3.0 Multi Rail
Desktop Platform Power Supply**



thermaltake

Thank you!