

Accessories

A x 5pcs

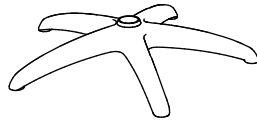

B x 1pc



C x 1pc



D x 1pc

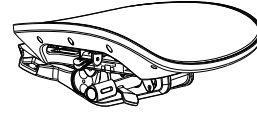

E x 1pc

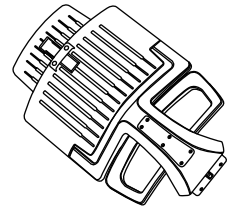

F x 2pcs



① x 4pcs 5/16 x 7/8"

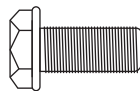

② x 6pcs 1/4 x 5/8"

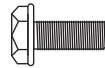

③ x 1pc M5



ATTENTION

- ▲ Carefully disassemble all parts and confirm all parts before installation.
- ▲ Tighten all screws after installation is complete.
- ▲ Make sure all screws are tightened before using the chair.
- ▲ Check every 90 days to make sure the screws are tight.

Step by step

Step 1

Install the caster wheels and gas lift onto the five-star base, Please note : When installing the caster wheels, hold the wheels at a 90-degree with a firm grip of the hand and do not use tools to knock it into place or the ground as to prevent damage.

Step 1

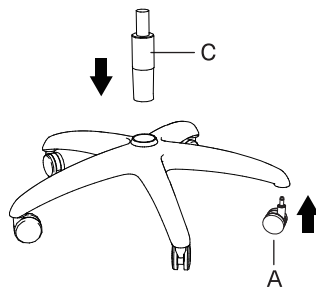

Step 2

Install the seat back and seat base, use (1) screws to secure the seat back and seat.

Step 2 ① x 4pcs

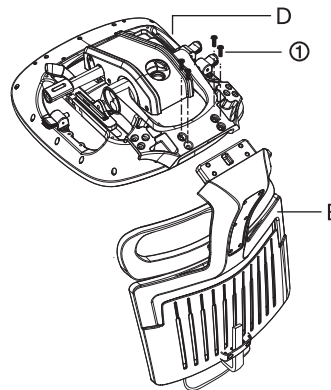

Step 3

Install the left and right armrests and use (2) screws to secure the left and right armrests.

Step 3 ② x 6pcs

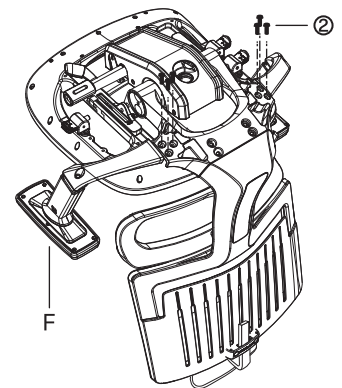

Step 4

Insert the assembled seat back and seat into the gas lift piston.

Step 4

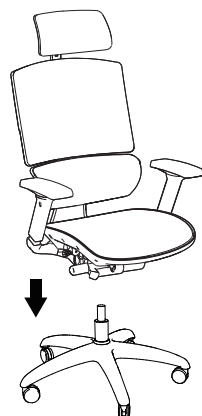

Step 5

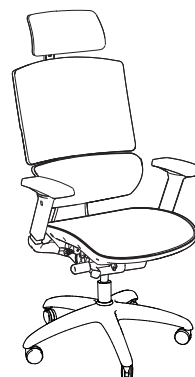

Step 5

Completed chair.

1. Seat backrest adjustment

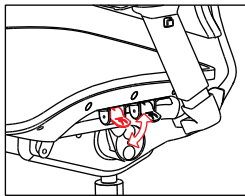
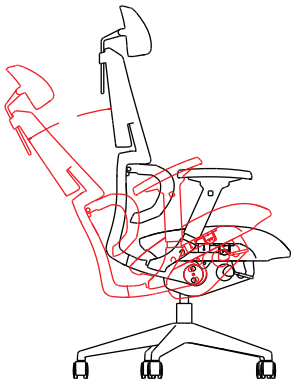

After sitting on the seat, adjust to the appropriate angle and lift the red position remote control switch to the upper plate to fix the seat back.

2. Front and rear adjustment of the seat base

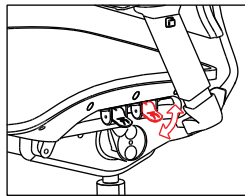

After sitting on the seat, move the red position control switch to the upper plate to move the seat. Pull the control switch down to fix the seat.

3. Seat height adjustment

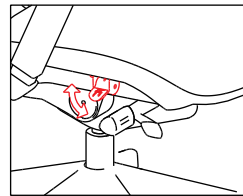
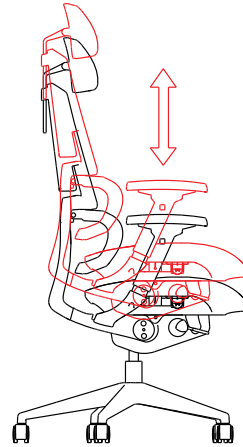

Lower the seat : sit down on seat and pull the switch up, and the seat will automatically descend.

Raise the seat : Stand up and pull the lever up, and the seat will automatically rise.

4. Adjustment of armrests

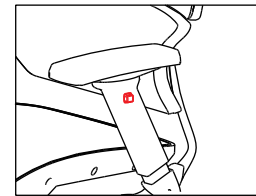
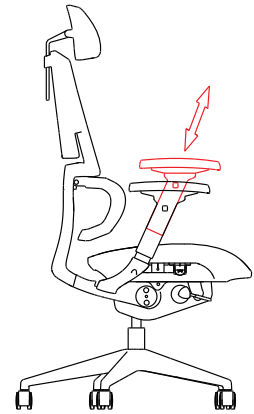

Press and hold the red button to adjust the height.

ATTENTION

1. Max load : 150kg/331lb
2. Do not stand on the chair.
3. Do not stand between two chairs
4. Do not sit on the corners of the chair
5. Do not sit on the armrest or the seat back
6. Do not do exercise on the chair
7. Do not place your fingers in any gap of the chair and be aware of your feet when moving the chair
8. Do not sit on the chair with over 1 person or spin or push the chair when someone is sitting on it
9. Do not pull the seat back when someone is sitting on it
10. While tilting down the seat back, extreme strength could lead to damage
11. While tilting down the seat back, do not place your legs on the table. Leaning on the chair while standing could lead to danger.
12. When leaning back on the chair, do not cross your legs on the table.
13. When standing, do not lean against the chair and the seat wheel may slip and cause injury.
14. While sitting on the chair, do not shake your body with extreme strength
15. This chair is only for sitting, any other use could lead to danger.
16. Please read the user manual thoroughly before usage of the chair

Fabric care guide:

Headrest, Backrest, Backseat, Armrest

1. Wipe the surface with a damp cloth.

Aluminum alloy metal care guide:

1. Dry wipe to remove dust. Do not wet with water to avoid rust.

2. If the metal encounters aluminum oxidation and fogging, you can use Metal Polish paste for maintenance.